

PROJECT	_____
TYPE	_____
SPECIFIER	_____
QUANTITY	_____
DATE	_____

## MEDIO MARINE GRADE RECESSED

### E9I588-

base number Color Lens  
Temperature Options

- To build a product code in our configurator select the specify button on the base model # product page
- To build a manual product code on this datasheet choose from the options listed below in blue font and add the suffix to the base model #

#### GENERAL

Series: Medio  
Subseries: Medio Marine Grade  
Brand: Platek  
Division: Exterior  
Mounting Type: Recessed  
Mounting Location: In-Ground  
Subcategory: Drive Over

#### PHYSICAL

Shape: Round  
Diameter (mm): 220  
Diameter (in): 8 <sup>11</sup>/<sub>16</sub>  
Height (mm): 113  
Height (in): 4 <sup>7</sup>/<sub>16</sub>  
Light Distribution: Uplight  
Weight (kg): 3.40  
Weight (lbs): 7.5  
Load Resistance (kg): 1500  
Load Resistance (lbs): 3307  
Installation Requirement: Installation in sleeve set in concrete with a 20-30 cm gravel drain bed  
Screws: A4 stainless steel  
Diffuser: Clear tempered glass  
Fixture Finish: SST  
Fixture Material: Stainless Steel AISI 316L  
Cable Details: Supplied with 1 power cable 1m in length

#### ELECTRICAL

Lamp Type: LED  
Input Wattage (W): 15  
Total Output Wattage (W): 14  
Driver Included: No  
Driver Location: Remote  
Driver Type: Constant Voltage - 120 / 277Vac  
Driver Class: Class 2  
Input Voltage (V): 120 - 277  
Output Voltage (V): 24  
Upon Request: (Not included - see components [IP65 or higher enclosure to be supplied by others]) 0-10Vdc dimming / Phase dimming / Non-dimming 120/277Vac

#### LED

Number of LEDs: 9  
Color Temperature (°K): 3000 / 4000  
Max. Delivered Lumen (lm): 1480 / 1540  
Nominal Lumen (lm): 1710 / 1800  
CRI: >80 CRI  
Lamp Life (hrs): 60000

#### OPTICAL

Optic: 9 / 28 / 45 / ELL

#### RATINGS AND CERTIFICATIONS

Certified By: Certified for North American Standards  
IP rating: IP68  
IK Rating: IK10  
Marine Grade: Stainless Steel AISI 316L  
Upon Request: Higher Maximum Ambient Temperature



220mm 8 <sup>11</sup>/<sub>16</sub>"

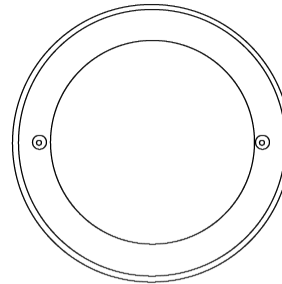

196mm 7 <sup>11</sup>/<sub>16</sub>"

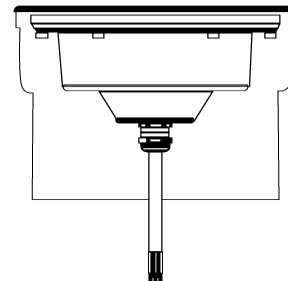

113mm 4 <sup>7</sup>/<sub>16</sub>"  
140mm 5 <sup>1</sup>/<sub>2</sub>"



## MEDIO MARINE GRADE RECESSED

E9I588-

PROJECT

TYPE

SPECIFIER

QUANTITY

DATE



## MEDIO RECESSED

### E91627-

base number Lens  
Options

- To build a product code in our configurator select the specify button on the base model # product page
- To build a manual product code on this datasheet choose from the options listed below in blue font and add the suffix to the base model #

#### GENERAL

Series: Medio  
Subseries: Medio  
Brand: Platek  
Division: Exterior  
Mounting Type: Recessed  
Mounting Location: In-Ground  
Subcategory: Drive Over

#### PHYSICAL

Shape: Round  
Diameter (mm): 206  
Height (mm): 230  
Height (in): 9 1/16  
Light Distribution: Uplight  
Weight (kg): 3.3  
Weight (lbs): 7.3  
Load Resistance (kg): 2000  
Load Resistance (lbs): 4409  
Installation Requirement: Installation in sleeve set in concrete with a 20-30 cm gravel drain bed  
Screws: A4 stainless steel  
Diffuser: Clear tempered glass  
Fixture Finish: BLK  
Fixture Material: Aluminum Die Cast  
Cable Details: Supplied with 1 power cable 1.5m in length

#### ELECTRICAL

Lamp Type: LED  
Input Wattage (W): 16  
Total Output Wattage (W): 16  
Dimming: Bluetooth technology or DMX  
Control Gear: DMX  
Driver Included: No  
Driver Location: Remote  
Driver Type: Constant Current - Universal  
Driver Class: Class 2  
Input Voltage (V): 120 - 277  
Constant Current (MA): 350

#### LED

Number of LEDs: 16  
Color Temperature (°K): RGBW  
CRI: >80 CRI  
Efficiency (%): 99.4  
Lamp Life (hrs): 60000  
Special LEDs offerings: RGBW

#### OPTICAL

Optic°: 9 / 28 / 44

#### RATINGS AND CERTIFICATIONS

Certified By: Certified for North American Standards  
IP rating: IP68  
IK Rating: IK10  
Upon Request: Higher Maximum Ambient Temperature

PROJECT	
TYPE	
SPECIFIER	
QUANTITY	
DATE	



Ø214mm 8 7/16"

Ø153mm 6"



230mm 9 1/16"

260mm 10 1/4"



E9I627-

PROJECT	_____
TYPE	_____
SPECIFIER	_____
QUANTITY	_____
DATE	_____



...



## MEDIO SS RECESSED

### E91628-

base number Lens  
Options

- To build a product code in our configurator select the specify button on the base model # product page
- To build a manual product code on this datasheet choose from the options listed below in blue font and add the suffix to the base model #

#### GENERAL

Series: Medio  
Subseries: Medio SS  
Brand: Platek  
Division: Exterior  
Mounting Type: Recessed  
Mounting Location: In-Ground  
Subcategory: Drive Over

#### PHYSICAL

Shape: Round  
Diameter (mm): 214  
Diameter (in): 8 7/16  
Depth (mm): 230  
Depth (in): 9 1/16  
Light Distribution: Uplight  
Weight (kg): 4.4  
Weight (lbs): 9.7  
Load Resistance (kg): 2000  
Load Resistance (lbs): 4409  
Installation Requirement: Installation in sleeve set in concrete with a 20-30 cm gravel drain bed  
Screws: A4 stainless steel  
Diffuser: Clear tempered glass  
Fixture Finish: SST  
Fixture Material: Aluminum Die Cast  
Cable Details: Supplied with 1 power cable 1.5m in length

#### ELECTRICAL

Lamp Type: LED  
Total Output Wattage (W): 16  
Dimming: Bluetooth technology or DMX  
Control Gear: DMX  
Driver Included: No  
Driver Location: Remote  
Driver Type: Constant Current - Universal  
Driver Class: Class 2  
Input Voltage (V): 120 - 277  
Constant Current (MA): 350

#### LED

Number of LEDs: 16  
Color Temperature (°K): RGBW  
CRI: >80 CRI  
Lamp Life (hrs): 60000  
Special LEDs offerings: RGBW

#### OPTICAL

Optic°: 9 / 28 / 45  
Adjustability: Tilt 15°

#### RATINGS AND CERTIFICATIONS

Certified By: Certified for North American Standards  
IP rating: IP68  
IK Rating: IK08  
Upon Request: Higher Maximum Ambient Temperature

PROJECT	
TYPE	
SPECIFIER	
QUANTITY	
DATE	



Ø214mm 8 7/16"

Ø153mm 6"

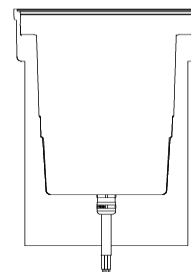
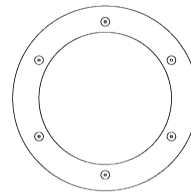

230mm 9 1/16"

260mm 10 1/4"



E91628-

PROJECT	_____
TYPE	_____
SPECIFIER	_____
QUANTITY	_____
DATE	_____



...



## MEDIO MARINE GRADE RECESSED

### E91629-

base number Lens  
Options

- To build a product code in our configurator select the specify button on the base model # product page
- To build a manual product code on this datasheet choose from the options listed below in blue font and add the suffix to the base model #

#### GENERAL

Series: Medio  
Subseries: Medio Marine Grade  
Brand: Platek  
Division: Exterior  
Mounting Type: Recessed  
Mounting Location: In-Ground  
Subcategory: Drive Over

#### PHYSICAL

Shape: Round  
Diameter (mm): 220  
Diameter (in): 8 <sup>11</sup>/<sub>16</sub>  
Height (mm): 113  
Height (in): 4 <sup>7</sup>/<sub>16</sub>  
Light Distribution: Uplight  
Weight (kg): 3.40  
Weight (lbs): 7.5  
Load Resistance (kg): 1500  
Load Resistance (lbs): 3307  
Installation Requirement: Installation in sleeve set in concrete with a 20-30 cm gravel drain bed  
Screws: A4 stainless steel  
Diffuser: Clear tempered glass  
Fixture Finish: SST  
Fixture Material: Stainless Steel AISI 316L  
Cable Details: Supplied with 1 power cable 1m in length

#### ELECTRICAL

Lamp Type: LED  
Input Wattage (W): 16  
Total Output Wattage (W): 16  
Dimming: Bluetooth technology or DMX  
Control Gear: DMX  
Driver Included: No  
Driver Location: Remote  
Driver Type: Constant Current - Universal  
Driver Class: Class 2  
Input Voltage (V): 120 - 277  
Constant Current (MA): 350

#### LED

Number of LEDs: 16  
Color Temperature (°K): RGBW  
CRI: >80 CRI  
Lamp Life (hrs): 60000  
Special LEDs offerings: RGBW

#### OPTICAL

Optic: 9 / 28 / 45 / ELL

#### RATINGS AND CERTIFICATIONS

Certified By: Certified for North American Standards  
IP rating: IP68  
IK Rating: IK10  
Marine Grade: Stainless Steel AISI 316L  
Upon Request: Higher Maximum Ambient Temperature

PROJECT	
TYPE	
SPECIFIER	
QUANTITY	
DATE	



220mm 8 <sup>11</sup>/<sub>16</sub>"

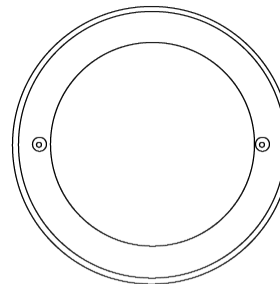

196mm 7 <sup>11</sup>/<sub>16</sub>"

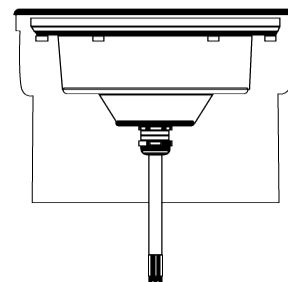

113mm 4 <sup>7</sup>/<sub>16</sub>"  
140mm 5 <sup>1</sup>/<sub>2</sub>"



## MEDIO MARINE GRADE RECESSED

E9I629-

PROJECT

TYPE

SPECIFIER

QUANTITY

DATE

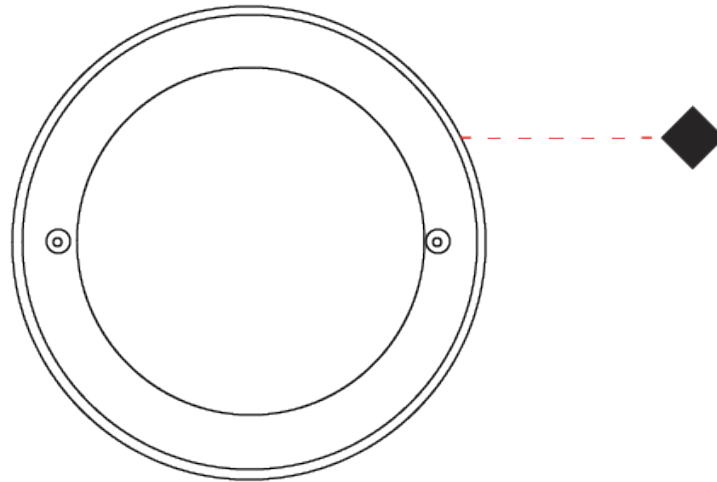



PROJECT

TYPE

SPECIFIER

QUANTITY

DATE

### Fixture Finish

Stainless Steel Inox - SST



Black - BLK



**Digital:** Not all screens are calibrated the same, and therefore, colors will appear differently between screens.

**Physical:** When texture is involved, there will be variations in color, character and tone within a product series and between product families.



PROJECT	
TYPE	
SPECIFIER	
QUANTITY	
DATE	

### LEGEND

	floor-mounted		pivotal		special LED (upon request) RGB, RGBW, tunable, gold+, meat+, art+, fashion+
	wall and ceiling: recessed and surface mounted		rotating		warm dim / natural dimming LED
	ceiling-mounted and wall-mounted		illuminate tilted		rechargeable battery powered
	wall-mounted		color of suspension cable		fixture with natural vivid LED (upon request)
	omni-directional light distribution		length of suspension cable		color rendering index
	direct light distribution		reflector degree selection		color temperature
	direct/indirect light distribution		super spot		lumen (luminous flux)
	indirect light distribution		lens		efficacy (lumens per watt)
	asymmetric light distribution		lens pack		Unified Glare Rating (UGR) range from 5-40
	aura light distribution		shine ring		marine grade (AISI 316 stainless steel)
	round wall or ceiling cut-out		integrated shine ring with diffuser		walk on
	square wall or ceiling cut-out		free individual colors 01-29		drive on
	the supplied jig specifies the cutout dimensions		individual colors: 00 (free of charge), 01-25 (extra charge)		Dark Sky Compliance
	minimum distance (meters) lamp - object		luminaire part to be colored (F1)		Americans with Disabilities Act (less than 4" off the wall located between 27"-84" from floor)
	recessed depth		luminaire part to be colored (F2)		lamp protected against explosion
	ceiling thickness in mm		luminaire part to be colored (F3)		blown glass using traditional methods by master glass blower
	ceiling thickness selection		luminaire part to be colored (F4)		acoustic material
	dimmable DP (phase), DV (0-10V), DD (dali), DS (step-dim)		luminaire part to be colored (F5)		protection class I, protection insulation
	included or excluded LED driver/transformer/control gear		color of 3-circuit adaptor		protection class II, protection insulation
	separately switchable		indirect diffuser		ETL Certified to UL and CSA Standards
	sensor		direct diffuser		UL Certified to UL and CSA Standards
	remote control		ball-proof (upon request)		CSA Certified to UL and CSA Standards
	available upon request		accessory		Certified for North American Standards

### IP RATING

	protected against ingress of solid bodies greater than 12.5mm (finger)
	protected against ingress of solid bodies greater than 2.5mm protected against sprays of water up to 60 degrees from the vertical (rain)
	protected against ingress of solid bodies greater than 1mm (wire) no protection against the ingress of moisture
	protected against ingress of solid bodies greater than 1mm (wire) protected against sprays of water up to 60 degrees from the vertical (rain)
	protected against ingress of solid bodies greater than 1mm (wire) protected against water splashed from all directions
	protected against limited ingress of dust (wet rooms/covered outdoor areas) protected against water splashed from all directions
	protected against ingress of dust protected against jets of water
	protected against ingress of dust protected against powerful jets of water or heavy seas
	protected against ingress of dust protected against immersion of water between 15cm - 1m for 30 minutes
	protected against ingress of dust protected against immersion of water under pressure for long periods

### IK RATING

	protected against 0.14 joules impact (equivalent to 0.25kg mass dropped from 56mm above the surface)
	protected against 0.2 joules impact (equivalent to 0.25kg mass dropped from 80mm above the surface)
	protected against 0.35 joules impact (equivalent to 0.25kg mass dropped from 140mm above the surface)
	protected against 0.5 joules impact (equivalent to 0.25kg mass dropped from 200mm above the surface)
	protected against 0.7 joules impact (equivalent to 0.25kg mass dropped from 280mm above the surface)
	protected against 1 joules impact (equivalent to 0.25kg mass dropped from 400mm above the surface)
	protected against 2 joules impact (equivalent to 0.5kg mass dropped from 400mm above the surface)
	protected against 5 joules impact (equivalent to 1.7kg mass dropped from 300mm above the surface)
	protected against 10 joules impact (equivalent to 5.0kg mass dropped from 200mm above the surface)
	protected against 20 joules impact (equivalent to 5.0kg mass dropped from 400mm above the surface)